



FLL[®] TRASH TREKSM Project



In the TRASH TREKSM Project, your team will:

- Identify a problem with the way we make or handle trash
- Design an innovative solution to the problem you select
- Share your problem and solution with others

Think About It

Have you ever thought about the disposable plastic straw in your drink at a restaurant? When you finish your meal and leave, what happens to the straw?

9-year-old Milo Cress started asking these questions when he noticed that restaurants usually gave him a disposable straw with each beverage. The straw was there even if he didn't need or want it. Milo recycled a lot of his trash at home, but he was not able to recycle disposable straws. This seemed like a problem that needed some investigation.

From Milo's research, he estimated that people in his country use over 500 million straws every day. That adds up to about 9,300 large busses full of disposable straws. Milo thought that added up to too much unnecessary trash in landfills!

To solve this problem, Milo thought maybe restaurants could stop giving straws automatically. Some people would decide not to take a straw, and fewer straws would go into the trash. Milo's Be Straw Free campaign encourages everyone – especially kids – to say “no straw, please” at restaurants.

As Milo said “I'm not the straw police. I'm not saying ‘no straws at all!’” Milo just encourages people to consider other options, like buying a reusable or biodegradable straw. “That's something kids can do something about!”

Even if you do not use disposable straws, you definitely make some sort of trash every day. You might call it garbage, rubbish, or even Municipal Solid Waste (MSW). **For the TRASH TREK Challenge, trash is any item you are done with and want to dispose of.**



Have you thrown away any of these items today?

- Food scraps (like a banana peel or a chicken bone)
- Plastic bags or wrappers
- Used items (like a pen that won't write or an old school notebook)
- Clothes that are too small or ruined

Where you live, maybe most trash items go into a recycle bin. Maybe most go into a trash bag. Maybe most are burned. Whatever type of bin you put them into, those pieces of trash go somewhere when they leave your house. Do you know where they go?

Your Project mission this season is to make less trash or improve the way people handle the trash we make.





Identify a Problem

To begin your TRASH TREK project, choose a piece of trash and identify a problem with the way it is currently handled. Look for problems with the way we make, transport, store, or turn trash into something new. Then find out what is being done to solve the problem.

Not sure where to start? Try this process to choose and explore your trash problem:

As a Team – Choose a piece of trash. It might be something gross and stinky, something old and worn out, or something left over after you finish a project. It could be an item that is used in manufacturing, building, or some other business. It could be any item that is considered “trash” by the owner. (See box at right for exceptions.)

As a Team - Find out where your piece of trash goes after it leaves the owner. Think about questions like:

- Does someone collect this item from you, or do you need to take it somewhere?
- Could you follow the path your trash takes (either in person or through websites, books, and magazines)?
- What happens to the trash in the end?
- Do you notice any parts of the process that could be better – more efficient, cleaner, or better in some other way? Look for these problems as you research.

This might be a great time to interview a professional. The professional could be someone who works in the waste management industry or researches trash problems for their job. Can a professional help you learn about trash collection, recycling, composting, reusing, or processing your trash in some other way?

As a Team – Identify a problem with the way trash is handled and learn about it. You might select a problem in one of these areas (or add your own):

- Collecting trash
- Finding new uses for old items (repurposing)
- Food waste
- Electronics waste (phones, computers, etc.)
- Hazardous waste (medical, chemical, etc.)
- How trash impacts your community
- Landfills
- Making zero-waste products
- Recycling process
- Sorting

As a Team – After you select a problem, find out about the current solutions. Why aren't the current solutions working? Why does this problem still exist?



EXCEPTIONS:
For the TRASH TREKSM Project, trash does NOT include:

- Sewage
(Ex: waste water, human or animal excrement)
- Gasses
(Ex: car exhaust)



IDENTIFY A PROBLEM:
How does a city planner, a sanitation worker, a composter, an anthropologist, an engineer, or a scrap dealer work with trash?





Design an Innovative Solution

Next, design an innovative solution to your problem – **a solution that adds value to society by improving something that already exists, using something that exists in a new way, or inventing something totally new.**

As a Team – Think about:

- What could be done better? What could be done in a new way?
- Could your solution make it more cool, fun, or easy to be responsible about trash?
- How can you reimagine disposing of trash to make it more efficient or safe?
- Could your solution prevent an item from becoming trash in the first place?

Think of your problem like a puzzle. Brainstorm! Try one idea (or more), but be prepared that your first idea may not work as you expect. Then turn the problem upside down and think about it in a completely different way. Imagine! Get silly! Even a “silly idea” might inspire the perfect solution.

Have you thought about how someone could make your solution a reality? The research you have done will help you answer questions like:

- Why would your solution succeed when others have failed?
- What would it cost?
- Do you need any special technology to make your solution?
- Can anyone use your solution, or only some people?

Remember, your idea does not need to be completely new. Inventors often improve an idea that already exists or use something that exists in a new way.



KEEP ASKING QUESTIONS

Lots of questions – and tweaking your ideas to create something even better.

Share with Others

Once you design your solution, share it!

As a Team – Think about who your solution might help. How can you let them know? Can you present your research and solution to people who recycle, transport, store, reuse, or create trash? Can you share with a professional or someone who helped you learn about your problem? Can you think of any other groups of people who might be interested in your idea?

Consider including someone who could provide feedback about your solution. Getting input and improving are part of the design process for any engineer. Don't be afraid to revise your idea if you receive some helpful feedback.

When you present, use the talents of your team members. Find a creative way to explain your problem and solution. Your sharing can be simple or elaborate, serious or designed to make people laugh while they learn.

No matter what presentation style you choose, remember to have fun!





Present Your Solution at a Tournament

Finally, prepare a presentation to share your work with the judges at a tournament. Your presentation can include posters, slideshows, models, multimedia clips, props, costumes, and more. Be creative, but also make sure you cover all the essential information.

To be eligible for Project Awards and advancement your team must:

- Identify your problem.
- Explain your team's innovative solution.
- Describe how you shared your team's findings with others.
- Meet the presentation requirements:
 - Give your presentation live; you may use media equipment (if available) only to enhance the live presentation.
 - Include all team members; each team member must participate in the Project judging session.
 - Set up and complete your presentation in 5 minutes or less with no adult help.

You can learn more about how your team's presentation will be judged by reviewing the Rubrics located at <http://www.firstlegoleague.org/event/judging>.

Project Resources

- Check the Project Updates often: www.firstlegoleague.org/challenge/2015trashtrek. Here FLL staff will clarify common Project questions. Updates supersede anything in the Challenge document and will be in effect at tournaments.
- Download additional resources from the TRASH TREK Challenge page: www.firstlegoleague.org/challenge/2015trashtrek. The Topic Guide contains a glossary of trash industry words, a list of websites and books to start your research, and tips on how to approach professionals.
- Read the *FIRST*® LEGO® League Coaches' Handbook for more information about the Challenge, tournaments, and judging: www.firstlegoleague.org/challenge/teamresources.
- Download the *FIRST* app on your mobile device to access all the resources listed above in one place: www.firstlegoleague.org/challenge/teamresources.



All of us have items we are done using and need to dispose of. How we make and handle those items — that trash — can make a difference for people, businesses, and the planet. How do you want to clean up the trash?





Robot Game: Field Setup

The Field is where the Robot Game takes place.

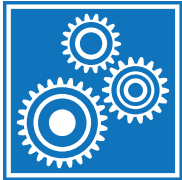

- It consists of a Field Mat, on a Table with Border Walls, with Mission Models arranged on top.
- The Field Mat and the LEGO® pieces (elements) for building the Mission Models are part of your Field Setup Kit.
- The instructions for building the Mission Models are [here](#).
- The instructions for how to build the Table and how to arrange everything on it are below...

Table Construction

The Robot Game takes place on a specially designed Table, so you'll need to build one to practice on if you don't already have access to one. With safety, weight, height, and cost in mind, a simple design is offered here, but as long as your surface is smooth, and your Border Walls are sized and located properly, how you build the understructure is up to you. The construction is simple, but does require some wood-working skill.

At a tournament, two Tables are placed back to back, but you only operate on one Table, so you only need to build one Table to practice on. Consider your practice Table a "Half-Table."

Most challenges have a "shared" Mission, whose Model(s) rest partly on your Table, and partly on the other team's Table. So in addition to building your Table, you'll need to build a small portion of a second Table, so both halves of the shared Model are supported. We call this added section the "Dummy Wall."

Here are the instructions for building one "Half-Table," plus a Dummy Wall:

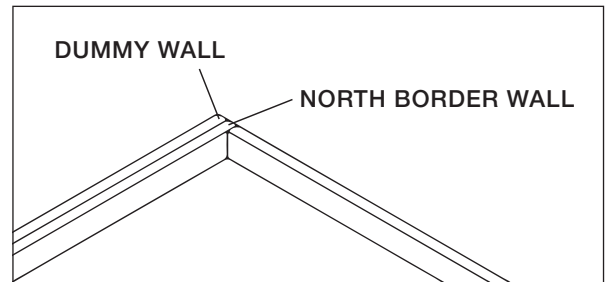

Materials

Material	Quantity
Field Setup Kit (Mission Model LEGO elements, mat, CD, Dual Lock™)	1
sanded plywood (or other very smooth board) 96" X 48" X at least 3/8" (2438mm X 1219mm X 10mm)	1
two-by-three, 8' (2438mm) [actual cross-section = 1-1/2" X 2-1/2" (38mm X 64mm)]	6
flat black paint	1 pt. (1/2 L)
coarse drywall screws, 2-1/2" (64mm)	1/2 lb. (1/4 kg)
saw horses, about 24" (610mm) high and 36" (914mm) wide	2





Parts (See Diagram Below)

Part	Make From	Dimensions	Paint	Quantity
Table surface (A)	plywood	96" X 48" (2438mm X 1219mm)	no	1
long Border Wall (B)	two-by-three	96" (2438mm)	yes	3
short Border Wall (C)	two-by-three	45" (1143mm)	yes	2
stiffener (D)*	two-by-three	48" (1219mm)	no	4
saw horse	purchase	H ≈ 24" W ≈ 36" (610mm) (914mm)	no	2

*If you are using a table surface thicker than 1/2" (13mm) check for warpage/distortion – you may NOT need stiffeners.

Assembly

Step 1 – See which face of the plywood (A) is least smooth, and consider that the bottom face. On the bottom face, clamp, then screw on the stiffeners (D) about every 18" (457mm). Be sure screw heads and splinters don't protrude.

Step 2 – On the top face of the plywood, locate, clamp, and screw on the Border Walls (B, C) around the top perimeter.

- The wall-to-wall dimensions must measure 93±1/8" by 45±1/8" (2362±3mm by 1143±3mm).
- The height of B and C must measure between 2-1/2" (64mm) and 3-1/2" (90mm).
- All border walls must be the same height as each other on all tables at a tournament. Border heights at a tournament may be different than those on your practice table.

Step 3 – Place this table top on short saw horses (or milk crates, or anything else short and solid).

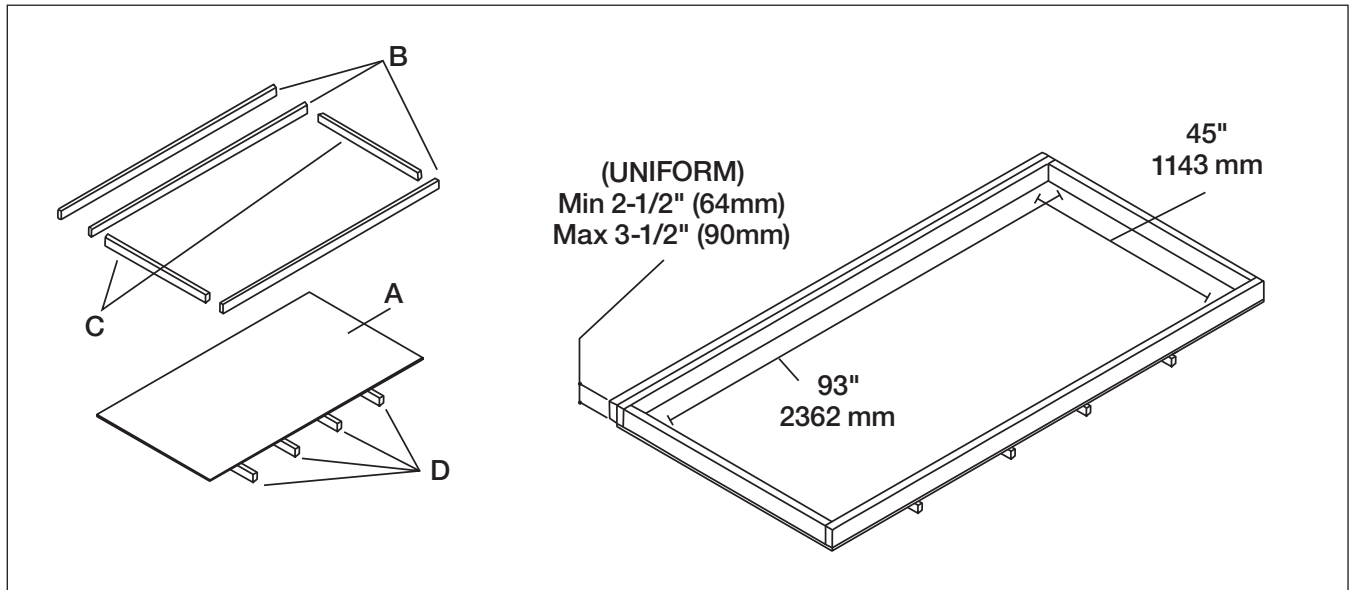



Field Mat Placement

STEP 1 – Vacuum the table top. Even the tiniest particle under the Mat can give the Robot trouble. After vacuuming, carefully run your hand over the surface and sand or file down any protruding imperfections you find. Then vacuum again.

STEP 2 – On the vacuumed surface (never unroll the Mat in an area where it could pick up particles), unroll the Mat so the image is up and its north edge is near the north/double Border Wall (note the location of the double wall in each Table sketch below). BE VERY CAREFUL TO NOT LET THE MAT KINK FROM BENDING IN TWO DIRECTIONS AT ONCE.

STEP 3 – The Mat is smaller than the playing surface by design. Slide and align it so that there is no gap between the south edge of the Mat and the south Border Wall, then center the Mat east-west, with equal gaps at left and right.

STEP 4 – With help from others, pull the Mat at opposite ends and massage out any waviness away from the center and re-check the requirement of Step 3. It is expected that some waviness will persist, but that should relax over time. Some teams use a hair dryer to speed the relaxation of the waviness.

STEP 5 – OPTIONAL - To hold the Mat in place, you may use a thin strip of black tape at the east and west ends. Where the tape sticks to the Mat, it may cover the Mat's black border only. Where the tape sticks to the Table, it may stick to the horizontal surface only, and not the Border Walls.

STEP 6 – For a competition setup, Dummy Walls are not needed. Secure two Tables north-to-north. The total span of Border between two Tables must measure between 3" (76mm) and 4" (100mm).

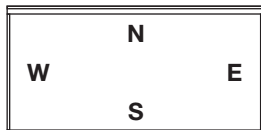
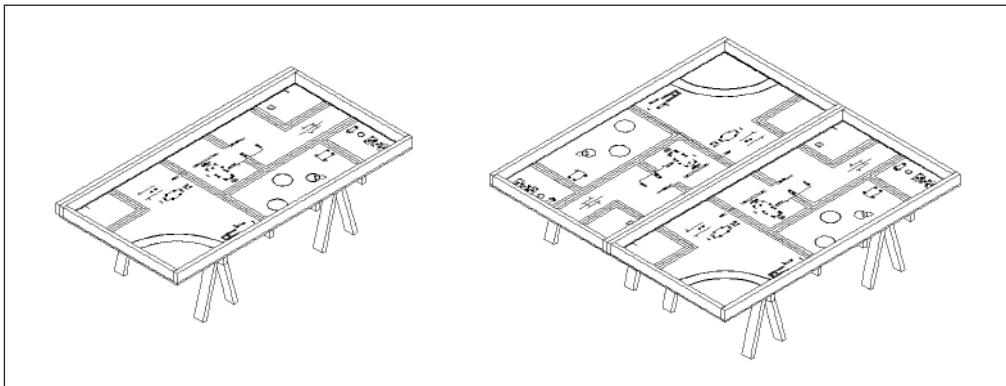

PRACTICE ("HALF TABLE")

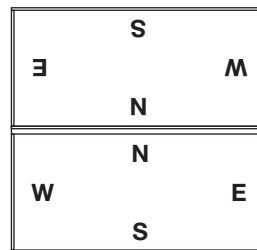

TOURNAMENT ("FULL TABLE")





Models (Any details not shown or mentioned are left to chance and officially don't matter.)

Methane – Secure the Holder exactly on its marks, then place the two Methane Loops in their holes, aligned as shown.

Landfill Bin – Secure as shown.

Turtle + Plastic Bag – Place exactly on their marks as shown.

Toys In Packaging – Place one Toy Plane in the Small Package on its mark as shown, and place the other Toy Plane in the Large Package which gets inserted in the Factory...

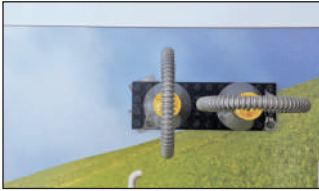

METHANE IN HOLDER

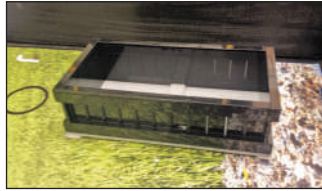

LANDFILL BIN



TURTLE + PLASTIC BAG

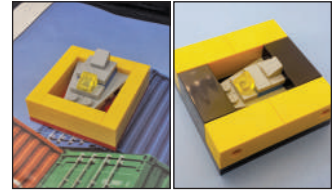

TOYS IN PACKAGING

SPECIAL NOTE ABOUT THE LARGE PACKAGE: This Model is designed to easily come apart into five pieces. Taking it apart is allowed as an exception to definition D08 below.

Factory – Secure the Factory, slide the loop fully in, and the Large Package with Toy Plane inside as shown.

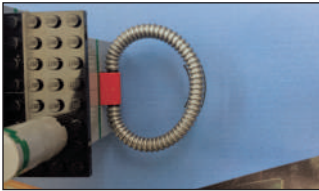

LOOP PUSHED IN



LARGE PACKAGE INSERTED

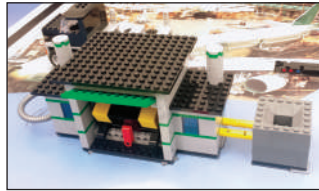

READY

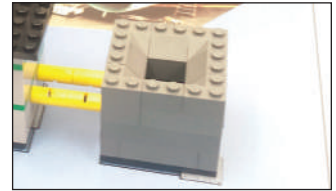

POWER STATION
(Mission Reference)

Car + Truck – Place each pointing west, aligned with its marks and arrows at the bottom of the front tires as shown.

Truck Guide – Secure exactly within its mark, with its tail east.



CAR

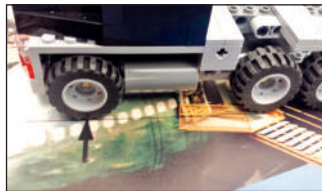

TRUCK



TRUCK GUIDE TAIL





Penalties – Place four Black Bars off the Field out of the way. At a tournament, these are in the Ref’s control.

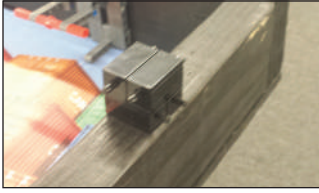

PENALTIES
(Example Placement)

Sorter – Secure exactly within its marks. For ease and accuracy, apply only two pairs of Dual Lock at a time.

- Be sure alignment at the end of the arrow is as close as possible.
- Secure the Bin Bracket, then place Green Bins as shown, with the north side of each Green Bin resting ON the Bin Bracket’s axle.
- Make sure the foot of the east chute rests between its tabs on the Bin Bracket as shown.
- Insert a Plastic Bag in its slot fully as shown.
- Load two Blue and two Black Bars in the red tray as shown, with studless plates up. Bar color order and axle directions are important; bar alignment is not. Refer to the small reminder on the Mat, south of the Sorter.
- Load the Yellow Bin containing a Yellow Bar as shown, centered east/west, with studless plates down.
- Finally, attach either all white or all black Identification Plates to the Green Bins as shown. Color is not important for practice, but will tell your Bins apart from the other team’s Bins at a tournament.

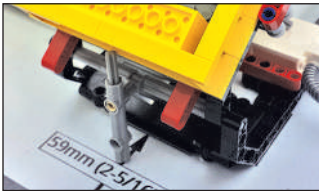

EXACT AT END OF ARROW

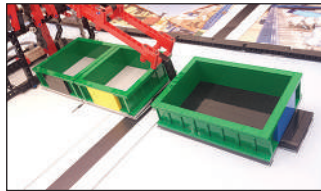

BIN BRACKET AND GREEN BINS

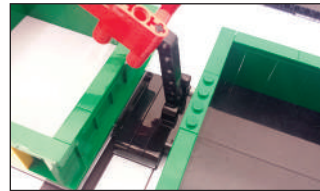

FOOT RESTS BETWEEN TABS

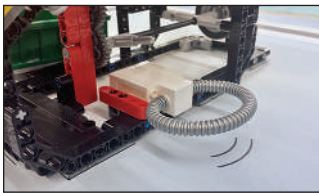

PLASTIC BAG

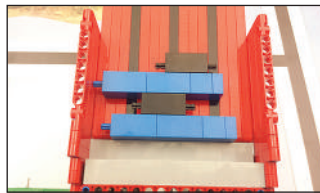

RED TRAY

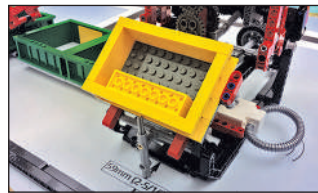

YELLOW BIN + YELLOW BAR

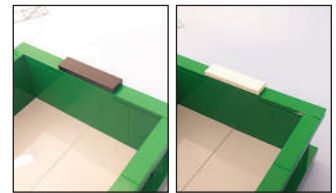

IDENTIFICATION PLATES

East Transfer – Secure to the inner surface of the north Border Wall. Use the Dual Lock pattern shown here, and align the Model’s foot with its marks on the Mat. Be sure the Model is level.

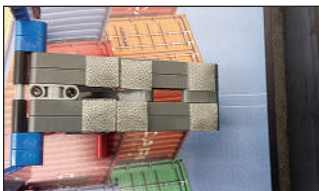

DUAL LOCK



ALIGN FOOT



LEVEL

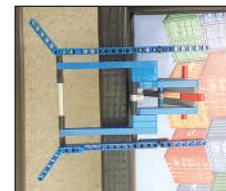

READY





West Transfer – Secure to the FAR side of a SECOND thickness of north Border Wall, known as a “Dummy Wall.” This arrangement is needed to replicate the spacing conditions at a tournament, where the north Border Wall is double-thick (one north wall for your Table, and one for the other team’s Table). Use the Dual Lock pattern shown here, and center the Model over its marks on the Mat. Secure the Model so it’s level, and the bottom of its foot is at the same height as the Mat.



DUMMY WALL

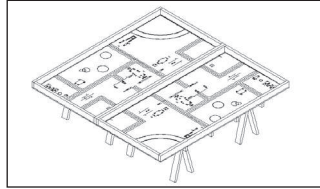

TOURNAMENT SETUP



DUAL LOCK PATTERN

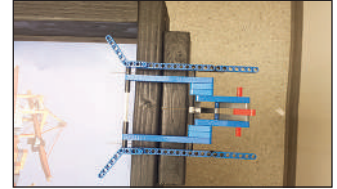

ALIGN WITH MAT MARKS



BOTTOM OF FOOT SAME HEIGHT AS MAT

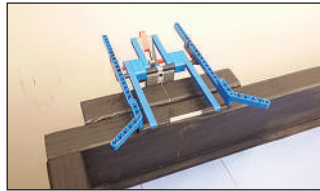

READY

Bracket + Building + Valuables – Secure the bracket exactly within its marks, red lever at northwest. Then use four of each color Bars to make the Building as shown, with studless plates facing west. Perfect Bar alignment is not expected. Finally, insert the Valuables fully onto the ground floor from the east as shown.



BUILDING ON BRACKET

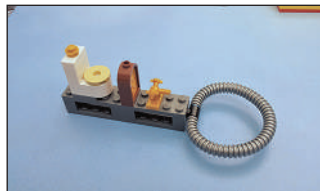

VALUABLES



READY

Composter – Secure exactly on its marks. Be sure the Model is pressed down tightly. The multistep setup for this Model takes a little bit of memory and practice:

STEP 1 – Pivot the red lever lock west.



STEP 1 – BEFORE



STEP 1 – AFTER





STEP 2 – Slide the black rocker arm & rubber tires north to disengage them from the red cross.



STEP 2 – BEFORE

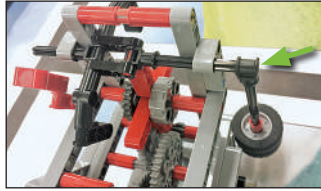

STEP 2 – AFTER

STEP 3 – Raise the food scrap bin gently/slowly all the way up and hold it there...

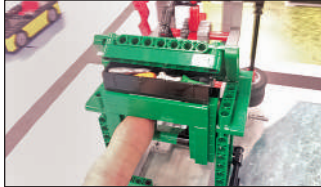

RAISING...

STEP 4 – While still holding the food scrap bin all the way up, undo Step 2, then undo Step 1.

STEP 5 – Push the rubber tires east out of the way, then slide the yellow plunger west, and let go of the rubber tires.

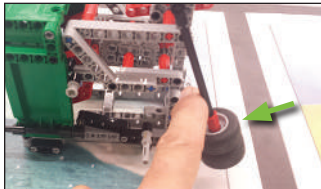

RUBBER TIRES OUT OF THE WAY



YELLOW PLUNGER WEST, AND LET GO

STEP 6 – Push the green lid west onto the food scrap bin and insert the Compost disc, studs up. This is needed!



PUSH GREEN LID ONTO SCRAPS

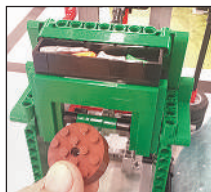
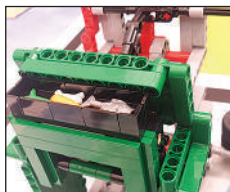

INSERT COMPOST DISC

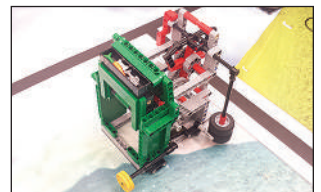

READY

Base – Loosely place these things in Base however you like: Octopus, Chicken, Engine/Windshield, two People, and two Yellow Bars. The spare set of Identification Plates are not part of the Field and may not be used as Equipment.



BASE CONTENTS

Loop Quality – Every time you handle a loop, make sure it's rounded as possible, and not rotated/deflected.





Overviews





Field Maintenance

- **Border Walls** – Remove any obvious splinters, and cover any obvious holes.
- **Field Mat** – Make sure the Mat touches the south Border Wall, and is centered east to west. Avoid cleaning the Mat with anything that will leave a residue. Any residue, sticky or slippery, will affect the Robot's performance compared to a new Mat (many tournaments use new Mats). Use a vacuum and/or damp cloth for dust and debris (above and below the Mat). To get marks off, try a white-plastic pencil eraser. When moving the Mat for transport and storage, be sure not to let it bend into a sharp kink point, which could affect the Robot's movement. Tournaments using new Mats should unroll the Mats as far in advance of the tournament day as possible. For control of extreme curl at the east or west edges of the Mat, black tape is allowed, with a maximum of ¼" (6mm) overlap. Foam tape is not allowed. Do NOT put Dual Lock under the Mat, or use it for anything other than securing Models as described.
- **Mission Models** – Keep the Models in original condition by straightening and tightening solid connections often. Ensure that spinning axles spin freely by checking for end-to-end play and replacing any that are bent.

DO NOT
put Dual Lock under the Mat, or use it for anything other than securing Models as described.





Robot Game: Rules

Guiding Principles

GP1 – Gracious Professionalism® – You are “Gracious Professionals.”

- You compete hard against PROBLEMS, while treating PEOPLE with respect and kindness – people from your own team, as well as other teams, and other countries.
- Coaches and parents lead by example.
- You build onto other people’s ideas instead of resisting or defeating them.
- If you joined *FIRST* LEGO League with a main goal of “winning a Robotics competition,” you’re in the wrong place!
- The Robot Game is developed and produced so you can:
 - have fun with science and technology, gaining confidence, knowledge, and skill at the same time.
 - practice taking risks and innovating in a team setting.
- Everyone running a tournament is a volunteer, including each Referee (Ref). Refs spend hours after work and on weekends to learn the Challenge, but you must expect them to occasionally make calls you disagree with.
- For every call you think cost you points incorrectly, another call probably gave you points incorrectly, and the same thing occasionally happens to all teams – please see the bigger picture.

GP2 – Interpretation

- Robot Game text means exactly and only what it says. Take it literally whenever possible.
- If taking text literally seems to allow an arguably clever strategy or advantage, then it’s allowed.
- If taking text literally leads to something outrageous/absurd, take the more popular/“common sense” meaning.
- If a word isn’t given a game definition, use its common/dictionary meaning.
- If a detail isn’t mentioned, it doesn’t matter.

GP3 – Benefit of the Doubt – You get the “benefit of the doubt” when the Ref...

- thinks a faulty Model or poor Field setup/maintenance is a factor.
- thinks a split-second or the thickness of a line is a factor.
- thinks a situation could “go either way” due to confusing, conflicting, or missing information.
- is unable to point to compelling official text to support a call.

This good-faith courtesy is not to be used as a strategy.

GP4 – Variability – Our suppliers, donors, and volunteers try very hard to make all Fields correct and identical, but you should always expect/design for flaws and variability. Just a few examples...

- Border Walls
- Lighting
- Table surface and Mat
- Field setup



GP5 – Info Precedence

- In case of conflict between sources of game info, precedence/authority in descending order is...
 - #1 = Current Robot Game Updates text
 - #2 = Missions and Field Setup text
 - #3 = Rules text
 - #4 = Local Head Ref decision
- Pictures and video have no standing, except when referred to by text in #1, #2, or #3.
- Emails and Forum comments have no standing, even from official sources. Consider them opinion.

Definitions

D01 – Autonomous – A Launched Robot is said to be “Autonomous” – performing with no help.

D02 – Base – “Base” is over the Field’s inner quarter-circle. It extends to the inner south and west Border Walls, but no farther, and has an invisible ceiling 12” (30.5cm) high. Base is important during Robot Launches/re-Launches only.

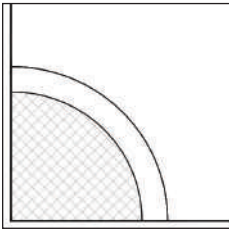

BASE FOOTPRINT

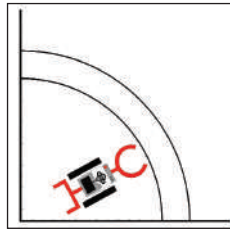

ROBOT “COMPLETELY IN” BASE

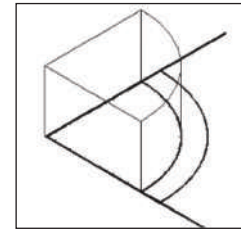

HEIGHT MATTERS DURING LAUNCH/RE-LAUNCH

D03 – Equipment – “Equipment” is everything you bring to a Match for Mission-related activity.

D04 – Field – The “Field” is the Robot’s game environment, consisting of LEGO Models on a Mat, surrounded by Border Walls. The Field is held on a Table. For full details, see Field Setup.

D05 – Interruption – If you interact with an Autonomous Robot, that’s an “Interruption.” No longer Autonomous, the Interrupted Robot is not allowed to move or do anything.

D06 – Match – A “Match” is when two teams play opposite each other on two Fields arranged back to back.

- Matches last 2-1/2 minutes.
- Your Robot Launches from Base and tries as many Missions as possible.
- The Field is not reset for the purpose of multiple attempts.
- Re-Launches are allowed during the Match, but the timer doesn’t pause.

D07 – Mission – A “Mission” is one or more objectives worth points.

- Some must be visible at the END of the Match.
- Some must be performed in a particular way, and must be watched by the Ref AS THEY HAPPEN.





D08 - Model – A “Model” (often called a “Mission Model”) is any LEGO structure already at the Field when you arrive to compete. You don’t bring Models to the competition Field – they’re already there when you arrive.

- You are not allowed to take Models apart, even temporarily.
- If you combine a Model with something, the combination must be loose enough that if asked to do so, you could pick the Model up and nothing else would come with it.

D09 – Penalties – A “Penalty” is a deduction from your final score due to a specific action that is allowed but discouraged. Penalty values are found in the Missions. There are two types of Penalty:

- Interruption Penalty – Caused by you Interrupting the Robot while it’s not completely in Safety.
- Junk Penalty – Caused...
 - immediately – by each piece of equipment the Robot strands partly in Safety.
 - at the end of the Match – by each piece of equipment still stranded completely outside Safety.

D10 – Robot – A “Robot” is a LEGO MINDSTORMS controller and all Equipment currently combined with it.

D11 – Safety – “Safety” contains Base, extends to the outer black arc, and has no ceiling.

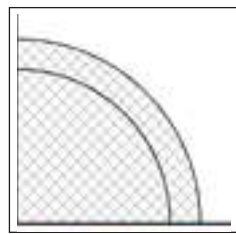

SAFETY FOOTPRINT

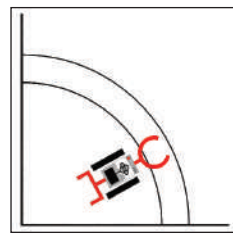

ROBOT “COMPLETELY IN” SAFETY

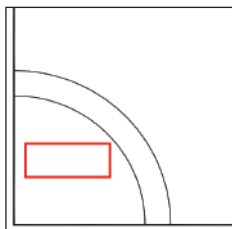

COMPLETELY IN BASE
COMPLETELY IN SAFETY

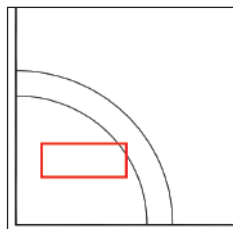

NOT COMPLETELY IN BASE
COMPLETELY IN SAFETY

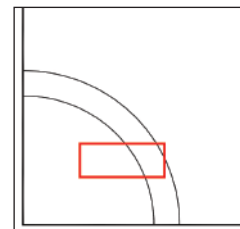

PARTLY IN SAFETY

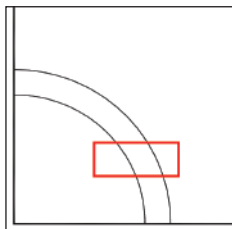

PARTLY IN SAFETY

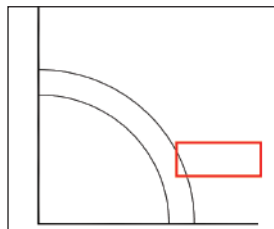

PARTLY IN SAFETY

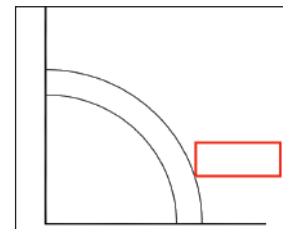

COMPLETELY OUTSIDE SAFETY





Equipment, Software, and People

R01 – All Equipment – All Equipment must be made entirely of LEGO-manufactured building elements in original factory condition.

- Except: LEGO string and tubing may be cut to length.
- Except: Reminders written on paper are okay.
- Except: Marker may be used only in hidden areas, for ownership identification.

R02 – Controllers – You are allowed only one individual controller in any particular Match.

- It must exactly match a type shown below (Except: Special-edition color differences are okay).
- All other controllers must be left in the pit area for that Match.
- All forms of remote control or data/info exchange with Robots including Bluetooth in the competition area are illegal.



EV3



NXT



RCX

R03 – Motors – You are allowed up to four individual motors in any particular Match.

- Each one must exactly match a type shown below.
- You may include more than one of a type.
Example: 3 EV3 LARGE + 1 EV3 MEDIUM = 4 motors = Okay.
- All other motors must be left in the pit area for that Match.
Example: If you have 3 motors installed in the Robot, you may have at most 1 other motor ANYWHERE with you.
Example: If you have 2 motors installed in the Robot, you may have at most 2 other motors ANYWHERE with you.

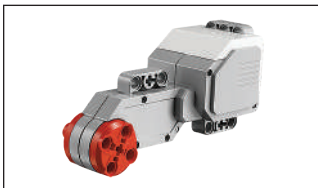

EV3 "LARGE"



EV3 "MEDIUM"



NXT



RCX





R04 – EXTERNAL SENSORS – Use as many external sensors as you like.

- Each one must exactly match a type shown below.
- You may include more than one of each type.

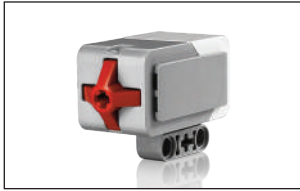

EV3 TOUCH



EV3 COLOR



EV3 ULTRASONIC



EV3 GYRO/ANGLE



NXT TOUCH



NXT LIGHT



NXT COLOR



NXT ULTRASONIC



RCX TOUCH



RCX LIGHT

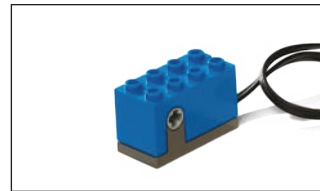

RCX ROTATION

R05 – Other Electric/Electronic Things – No other electric/electronic things are allowed in the competition area for Mission-related activity.

- Except: LEGO wires and converter cables are allowed as needed.
- Except: Allowable power sources are (1) controller’s power pack or (6) AA batteries.

R06 – Non-Electric Elements – Use as many non-electric LEGO elements as you like.

- Except: Factory-made wind-up/pull-back “motors” are not allowed.
- Except: Additional/duplicate Models are not allowed.

R07 – Software – The Robot may only be programmed using LEGO MINDSTORMS RCX, NXT, EV3, or RoboLab software (any release). No other software is allowed. Patches, add-ons, and new versions of the allowable software from the manufacturers (LEGO and National Instruments) are allowed, but tool kits, including the LabVIEW tool kit, are not allowed.

R08 – Technicians

- Only two team members, called “Technicians,” are allowed at the competition Field at once. Except: Others may step in for honest emergency repairs during the Match, then step away.
- The rest of the team must stand back as directed by tournament officials, with the expectation of fresh Technicians being able to switch places with current Technicians at any time.





Play

R09 – Pre-Match Preparation – After getting to the Field, you have at least one minute to prepare. During this time only, you may...

- ask the Ref to confirm that a Model or setup is correct.
- calibrate light/color sensors on the Field outside Safety.

R10 – Hands Off – If something on the Field is not completely in Safety, you are not allowed to touch it except as specifically described in a Mission, Rule, or Update.

R11 – Workspace and Storage

- **ON THE FIELD:** Handling and storage of allowable things may extend out of Safety, into adjacent irrelevant Field space only if specific actions and locations are completely non-strategic.
- **OFF THE FIELD:** Equipment and Models are not allowed on the floor.

R12 – Launching – A proper Launch (or re-Launch) goes like this:

- Ready Situation
 - Your Robot and everything related to its next Autonomous period are arranged as desired and all completely contained within and under the limits of BASE.
 - The Ref can see that nothing in Base is moving, and that you're not touching anything.
- Activation Method Options
 - **ACTIVE:** Reach with one hand and touch a button or signal a sensor to prompt a program.
 - **PASSIVE:** Do nothing and allow a running program to resume.

SPECIAL CASE: Match Start – In this case, the exact time to Launch is the beginning of the last word/sound in the countdown, such as “Ready, set, **GO!**” or **BEEEEEP!**
- The properly Launched/re-Launched Robot is Autonomous until you Interrupt it.
- Every change completely outside Safety caused by the Robot stays that way.
- Except: The Robot may change its own changes.
- You are not allowed to cause anything to leave or even extend out of Base except by Launching/re-Launching.
- If you accidentally propel something out of Base, that's okay to recover immediately without disturbing the Field.

R13 – Interrupting – If you **INTERRUPT** the Robot, you must stop it immediately, then *calmly pick it up for a re-Launch *if there will be one. Here's what happens to the Robot and any Model it was transporting, depending on where each was at the time...

- **Robot** – Completely in Safety?
 - YES: Re-Launch.
 - NO: Re-Launch + Interruption Penalty.
- **Model** – Completely in Safety?
 - YES: Keep it.
 - NO: Was it with the Robot during the most recent Launch?
 - YES: Keep it.
 - NO: Give it to the Ref (out of play).

*LENIENCY: If there is no re-Launch allowed/intended, leave everything stopped in place, and there's no Penalty or movement of anything. Your Match is considered finished. Use this leniency if your robot has no more to do, especially if it's out of control, or stuck and straining its motors.





R14 – Stranding – If the **UNINTERRUPTED** Robot loses contact with something it was transporting, that thing must be allowed to come to rest. Once it does, here’s what happens, depending on its rest location...

● **Equipment**

- Completely in Safety: Keep it.
- Partly in Safety: Take it completely into Safety + keep it + Junk Penalty (immediately logged on Ref’s Sheet).
- Completely outside Safety: Leave it as is.

● **Model**

- Completely in Safety: Keep it.
- Partly in Safety: Give it to the Ref (out of play).
- Completely outside Safety: Leave it as is.

You may hand-recover unintended fragments from a truly broken Robot any time, with no Penalty.

R15 – Field Damage – If the Autonomous Robot separates Dual Lock or breaks a Model, Missions obviously made possible or easier by this damage or the action that caused it do not score.

R16 – Interference

- You are not allowed to negatively affect the other team except as described in a Mission.
- Missions the other team tries but fails because of illegal or accidental action by you or your Robot score anyway.

R17 – End Of The Match – As the Match ends, everything must be preserved exactly as-is...

- If your Robot is moving, stop it ASAP and leave it in place.
- After that, hands off everything until after the Ref has given the okay to reset the table.

R18 – Scoring

- **Scoresheet** – The Ref recalls action and inspects the Field with you, Mission by Mission...
 - If you agree with the Ref on all facts, you sign the sheet, and the score is final.
 - If you don’t agree, tell the Ref nicely. Refs can be wrong, and when they are, they want to know. If there is any lingering disagreement, the Head Ref makes the final decision.
- **Impact** – Only your BEST regular Match score counts toward awards/advancement. Playoffs, if held, are just for extra fun.
- **Ties** – Ties are broken using 2nd, then 3rd highest scores. For a rare tie across all three Matches, tournament officials decide what to do.

Big/Serious Changes For 2015...

- Words have been cut by ~60%.
- Remaining ideas are simpler and many are VERY different – **WARNING** to Veteran teams!
Example: The Rules used to tell you “IN” meant “partly in” was okay. Now that Rule is gone, and “Completely In” is required throughout the Robot game.
- Questions will be answered by a contact in your region.





Robot Game: Missions

Background

The TRASH TREK Challenge is about what happens to things when we think we're done with them, or when we think they're no good any more. The truth is that with some imagination, we can get much more use out of them, or the materials they're made from. A really smart time to think about this is before we even make or buy them! Recycling is great, but that's only one part of a very big picture. As you work on the Missions, imagine how we might be able to innovate our way toward ZERO WASTE one day...

Missions

M01 – Using Recycled Material – Everything constructed, crafted, or manufactured is made from materials that originally came from nature. But most of those materials are limited, or take decades or even centuries to accumulate.

- **Basic Mission Description:** Get material discarded from someone else, but useful for you. You'll avoid taking from nature, and the material won't become waste.
- **Specific physical requirement, visible at the end of the match:** Green Bin containing at least one matching Yellow or Blue Bar, all from the other team, is completely in your Safety.
 - **Value:** 60 per bin in either safety... for each scoring bin in either safety, the other team gets the points too, and vice versa.

M02 – Methane – We want to avoid Landfills, but existing Landfills do produce Methane, which can be converted into energy.

- **Basic Mission Description:** Collect Methane from the Landfill Area and use it to help run the Truck and/or the Factory.
- **Specific physical requirement, visible at the end of the match:** Methane is in the Truck's engine compartment, and/or the Factory's Power Station.
 - **Value:** 40 per methane.
- **Leniency:** Full/Exact nesting is not required.

M03 – Transport – The distance a discarded material may need to travel is an important part of the equation when deciding what to do with that material.

- **Basic Mission Description:** Load the all-Yellow Material Bin onto the Truck to be transported east/unloaded.
- **Specific physical requirement, visible at the end of the match (score one or both):**
 - **Value:** 50 The Truck supports all of the Yellow Bin's weight.
 - **Value:** 60 The Yellow Bin is completely east of the Truck's Guide.



M04 – Sorting – As we strive toward zero waste, one of the most urgent needs for innovation is in the area of sorting. Current separation technology and processing can be difficult, expensive, limited, and error-prone.

- **Basic Mission Description:** Yellow/Blue Bars are recyclable. Black Bars are impurities we have no current way to use. Process Bars through the Sorter. Bars sorted into their matching Green Bins have positive potential.
- **Specific physical requirement, visible at the end of the match:**
 - Yellow/blue bars are in their matching green bin and the bin (bins score independently)...
 - ***Value: Per Bin** (See [M01](#) on page 23) is completely in the other team’s Safety, by way of your West Transfer.*
 - **Value: 7 Per Bar** is completely in your West Transfer Area and/or completely on your West Transfer.
 - ***Value: 6 Per Bar** was never completely in your West Transfer Area (all “Areas” are defined below).*
 - ***Method Constraint:** These require sequence/path as described, in addition to final positions.
 - Black bars are (bars score independently)...
 - **Value: 8 Per Bar** part of a scoring Flower Box, or in their original Setup position.
 - **Value: 3 Per Bar** in their matching Green Bin, or in the Landfill Bin.
 - **Value: Minus 8 Per Bar** anywhere else.

Method Constraint: Bars must only enter Green Bins directly from the Sorter’s east chute or CAREERS BONUS...

M05 – Careers – Many scientists, engineers, and technicians are needed to keep up with today’s trends in waste reduction.

- **Basic Mission Description:** Move at least one person to the Sorter Area to earn a helpful exception to the Rules.
- **Specific physical requirement, visible at the end of the match as needed:** At least one Person is completely in the Sorter Area.
 - **Value: 60 Plus this R10 Leniency Bonus:** Team technicians and/or the ref (if needed/asked) are allowed to unclog any east chute blockage by hand, and/or put mis-sorted bars into their correct bin, including bars that didn’t land in any bin.

This is a fun, dynamic Model with a small but real error rate, which will be well understood by Tournament season. So that we may all enjoy the Model, please use the [R10](#) leniency for Model errors, handle with care when doing so, use “Benefit Of The Doubt” for hand errors, and use common sense and good will the whole time.

M06 – Scrap Cars – There are hundreds of millions of Cars worldwide, made from an enormous variety of materials. Are we making the best use of Cars at the end of their lives? How much of a scrapped Car really gets re-used?

- **Basic Mission Description:** Fix the old Car by installing the Engine/Windshield, or fold the Car and sell it for scrap.
- **Specific physical requirement, visible at the end of the match as needed (Score Only One Way):**
 - **Value: 65** The Engine/Windshield unit is installed in the unfolded Car in the proper space and direction.*
 - **Value: 50** The Car is completely folded and completely in the East Transfer Area.
- ***Leniency:** Full/exact nesting is not required.
- **Method Constraint:** The Car must never cross into Safety, even partly.

M07 – Cleanup – For discarded material, the only outcome worse than waste is pollution. Plastic Bags for example, seem to be everywhere, causing a variety of problems – jamming Equipment, threatening Animals, etc.

- **Basic Mission Description:** Move Bags from the Sorter and/or the Beach, and return Animals to their favorite spots.
- **Specific physical requirement, visible at the end of the match as needed (Score Any That Apply):**
 - **Value: 30 Per Bag** Plastic Bags are completely in Safety.
 - **Value: 20 Per Animal** *Animals are completely in any circle which is completely empty of Plastic Bags.





- **Value:** 35 The Chicken is completely in the small circle.
- *The fish Food Scrap doesn't count as an Animal.

M08 – Composting – Discarded organic material doesn't have to become waste. It can be converted into fertilizer.

- **Basic Mission Description:** Start the Composting process. After some time, it will eject Compost.
- **Specific physical requirement, visible at the end of the match (Score Only One Way):**
 - **Value:** 60 The Compost is ejected, but not completely in Safety.
 - **Value:** 80 The Compost is completely in Safety.

M09 – Salvage – A building being demolished should only be a shell of its former self. Many tons of valuable materials and objects can be salvaged first.

- **Basic Mission Description:** Move the Valuables to Safety.
- **Specific physical requirement, visible at the end of the match:**
 - **Value:** 60 The Valuables are completely in Safety.

M10 – Demolition – Compared to the amount of material discarded by a family every week, the amount of material discarded from a demolition site is unbelievable. Where does it all go? Where SHOULD it all go?

- **Basic Mission Description:** Demolish the Building and decide what to do with the materials.
- **Specific physical requirement, visible at the end of the match:**
 - **Value:** 85 None of the Building's twelve beams is left standing in Setup position.

M11 – Purchasing Decisions – Some manufacturers put products in packaging which is hard or impossible to divide into pure sorted recyclables. What choices do you have when you see that?

- **Basic Mission Description:** Decide about buying Toy Planes based on their Packaging.
- **Specific physical requirement, visible at the end of the match:**
 - **Value:** 40 Per Plane Toy Planes are completely in Safety.

M12 – Repurposing – Recycling gives new life to the materials an object is made from, but the process does take time and energy. Instead, is there a way to give new life to the object itself?

- **Basic Mission Description:** Use the packaging from a Toy Plane as a flower box by putting compost in it.
- **Specific physical requirement, visible at the end of the match:**
 - **Value:** 40 The Compost is perfectly nested inside one of the Packages from which a Toy Plane has been removed. The Package is in original condition.

Penalties – For each Penalty as described in Rule [D09](#), the Ref will place one Black Bar on the Mat in a convenient out-of-the-way place, not to exceed four Bars. The Ref may shift them out of the Robot's way as needed, but they must always stay in a negative scoring position.





- **Value:** See SORTING mission, black bar details above

“Areas” – Where the Missions refers to the Landfill Area, Sorter Area, or East Transfer Area, those areas are defined by the inner white strips, colored red below. Each area is defined as only the space above and inward from those white strips. Anything still partly above the adjacent thick black line doesn’t count as being in the area.

